

1 2 3 4 5 6

A

B

C

D

A

B

C

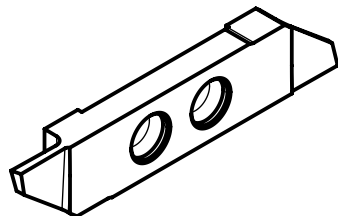
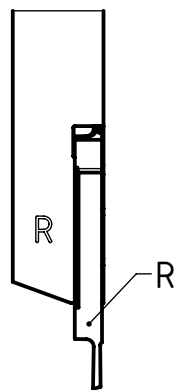
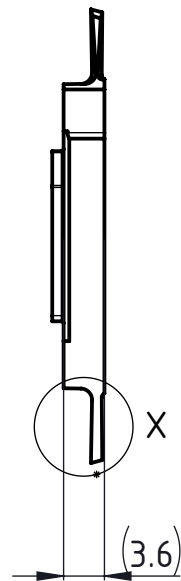
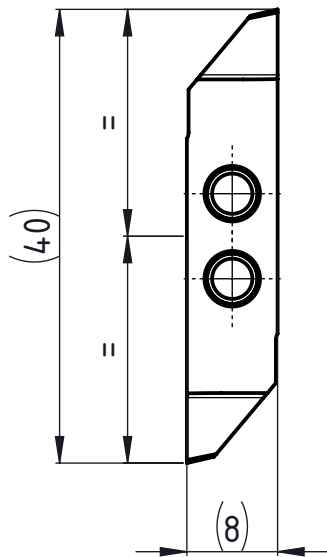

D

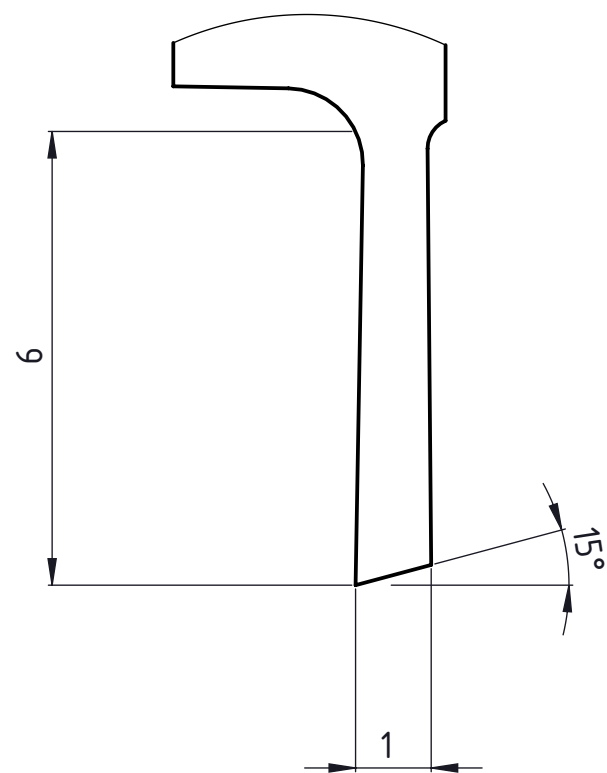

X (10 : 1)



Rechte Ausführung
 Execution droite
 Right execution

Beschreibung multidec CUT-Wendeplatte	Artikel Bezeichnung 3002-1.0-6 R	Zeichnungsnummer CUT-3002-01-03		 Index A
---	--	---	---	--